

TECHNICAL DRAWING

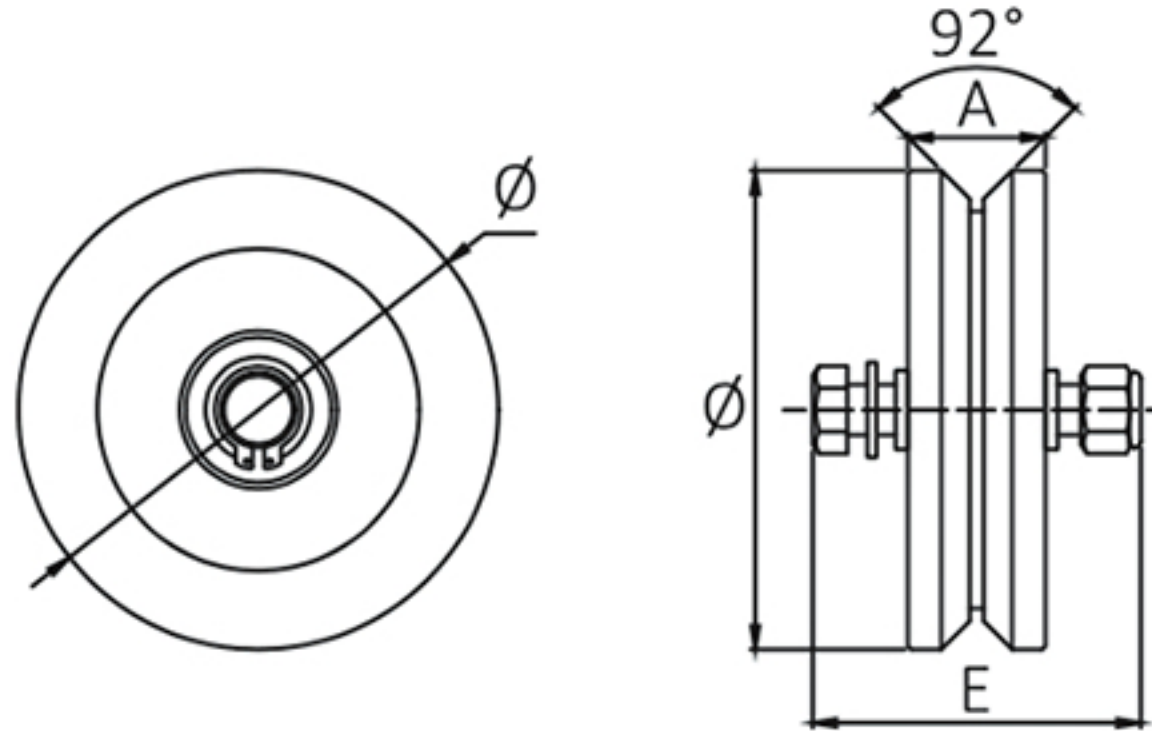

Model	Material	Description	Φ (mm)	A(mm)	E(mm)	Weight(kg)
TW-DB4Y	Steel	Roller	98	44	1/2"x95	2.44
TW-DB6Y	Steel	Roller	148	44	5/8"x90	5.55

Tower Industry
YOUR MANUFACTURING BASE IN CHINA

Sales@tower-machinery.com
www.tower-machinery.com

TW-DB4Y
V Groove Wheels

DIAMETER: 98MM
MATERIAL: Steel
WIDTH: 1/2"x95mm