

TECHNICAL DRAWING

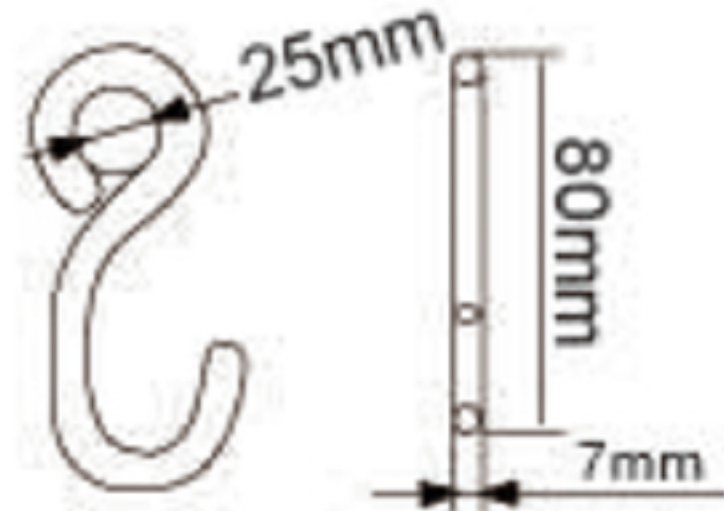

Tower Industry
YOUR MANUFACTURING BASE IN CHINA

Sales@tower-machinery.com
www.tower-machinery.com

TWSH15

S Hook

DESCRIPTION: S Hook
with Plastic Coating

BS: 600KG/1320LBS