

TECHNICAL DRAWING

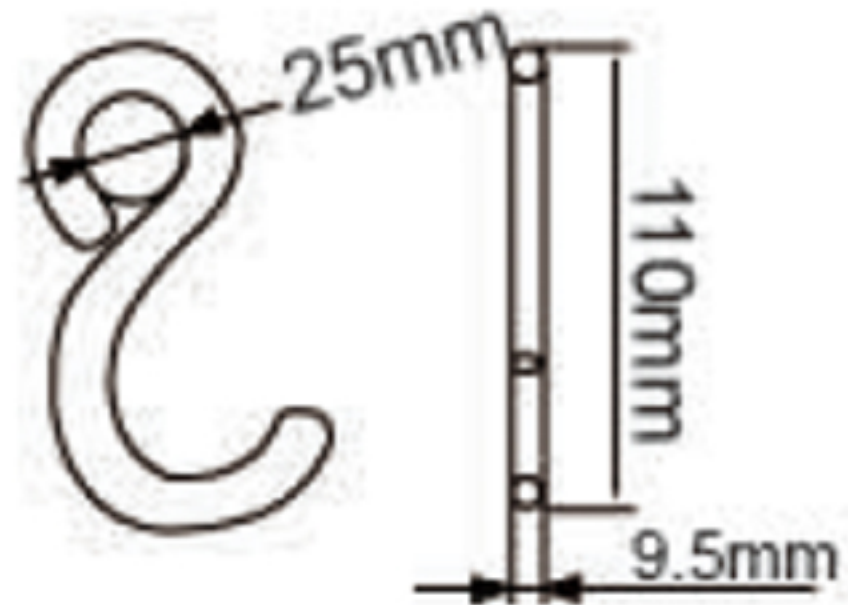

Tower Industry
YOUR MANUFACTURING BASE IN CHINA

Sales@tower-machinery.com
www.tower-machinery.com

TWSH07

S Hook

DESCRIPTION: S Hook
with Plastic Coating

BS: 1200KG/2540LBS