

TECHNICAL DRAWING

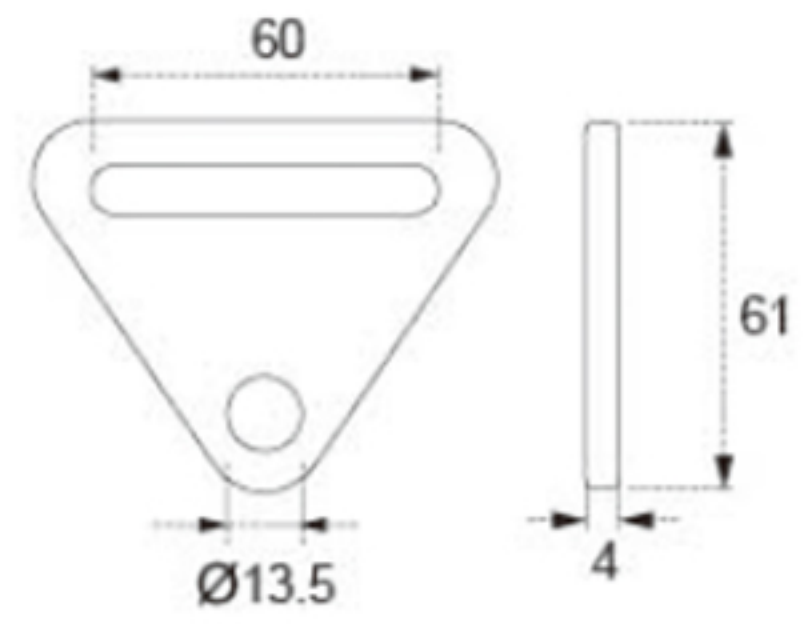

Tower Industry
YOUR MANUFACTURING BASE IN CHINA

Sales@tower-machinery.com
www.tower-machinery.com

TWHB13
Bolt Plate

SIZE: 2"
BS: 3000KG/6600LBS