

TECHNICAL DRAWING

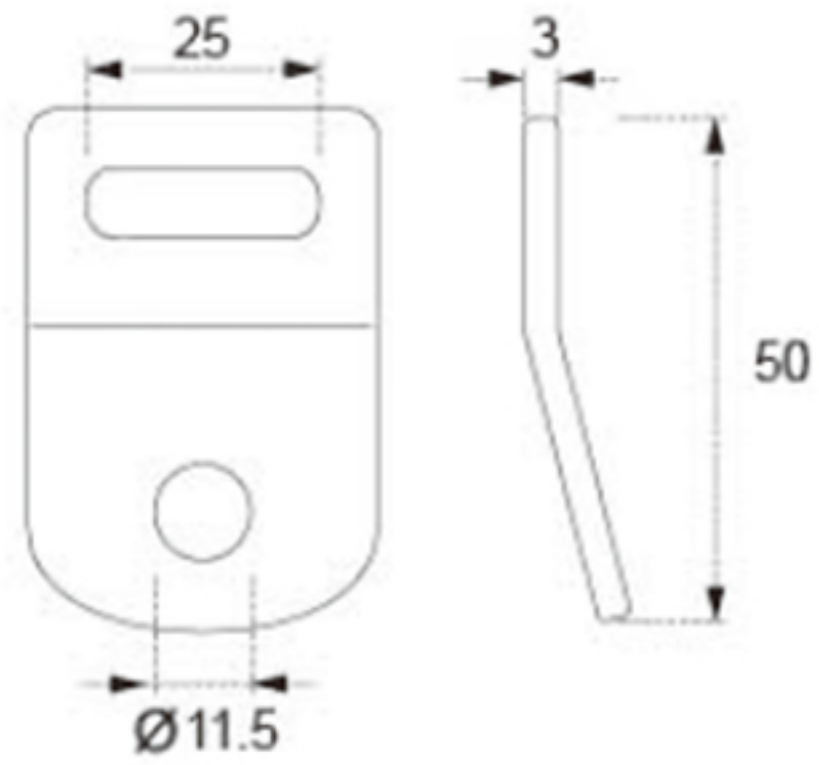

Tower Industry
YOUR MANUFACTURING BASE IN CHINA

Sales@tower-machinery.com
www.tower-machinery.com

TWHB06
Bolt Plate

SIZE: 1"
BS: 1000KG/2200LBS