

TECHNICAL DRAWING

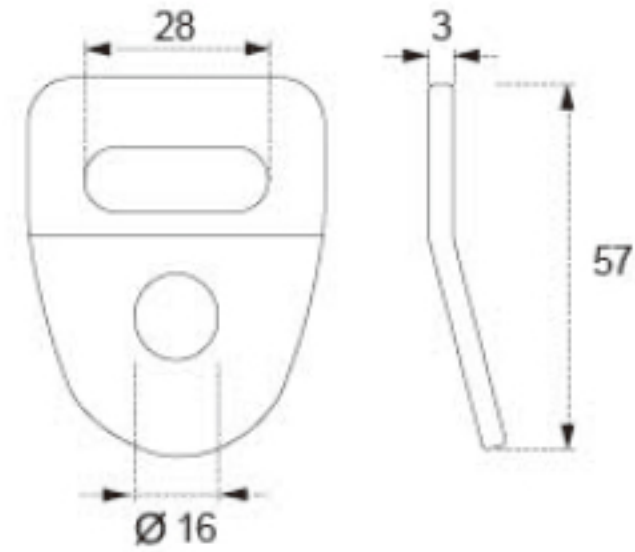

Tower Industry
YOUR MANUFACTURING BASE IN CHINA

Sales@tower-machinery.com
www.tower-machinery.com

TWHB05
Bolt Plate

SIZE: 1"
BS: 2000KG/4400LBS