

TECHNICAL DRAWING

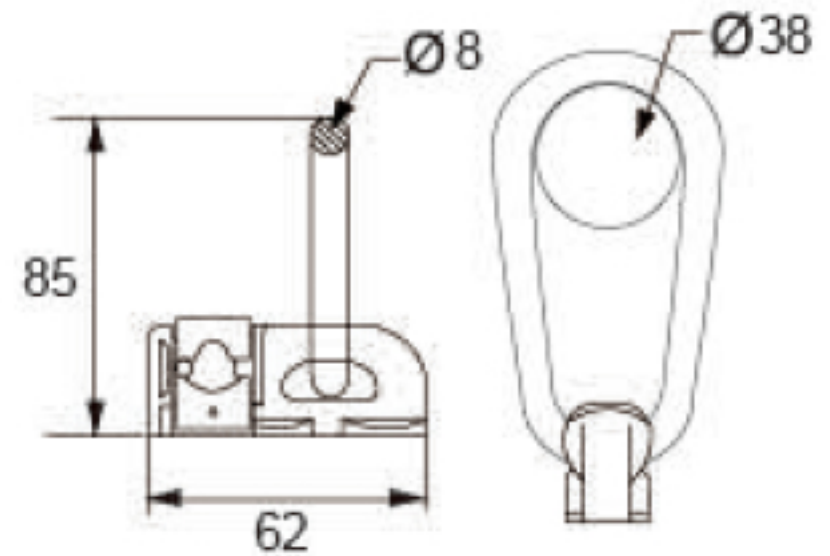

Tower Industry
YOUR MANUFACTURING BASE IN CHINA

Sales@tower-machinery.com
www.tower-machinery.com

TWEH11
E Tracking Fitting

SIZE:2"
BS: 2727KG/6000LBS