

TECHNICAL DRAWING

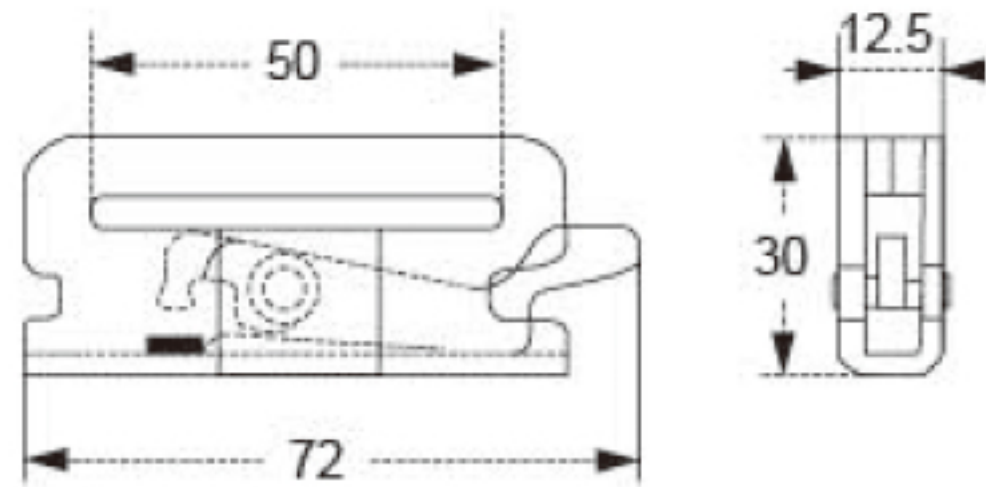

Tower Industry
YOUR MANUFACTURING BASE IN CHINA

Sales@tower-machinery.com
www.tower-machinery.com

TWEH03
E Tracking Fitting

SIZE:2"
BS: 2000KG/4400LBS