

TECHNICAL DRAWING

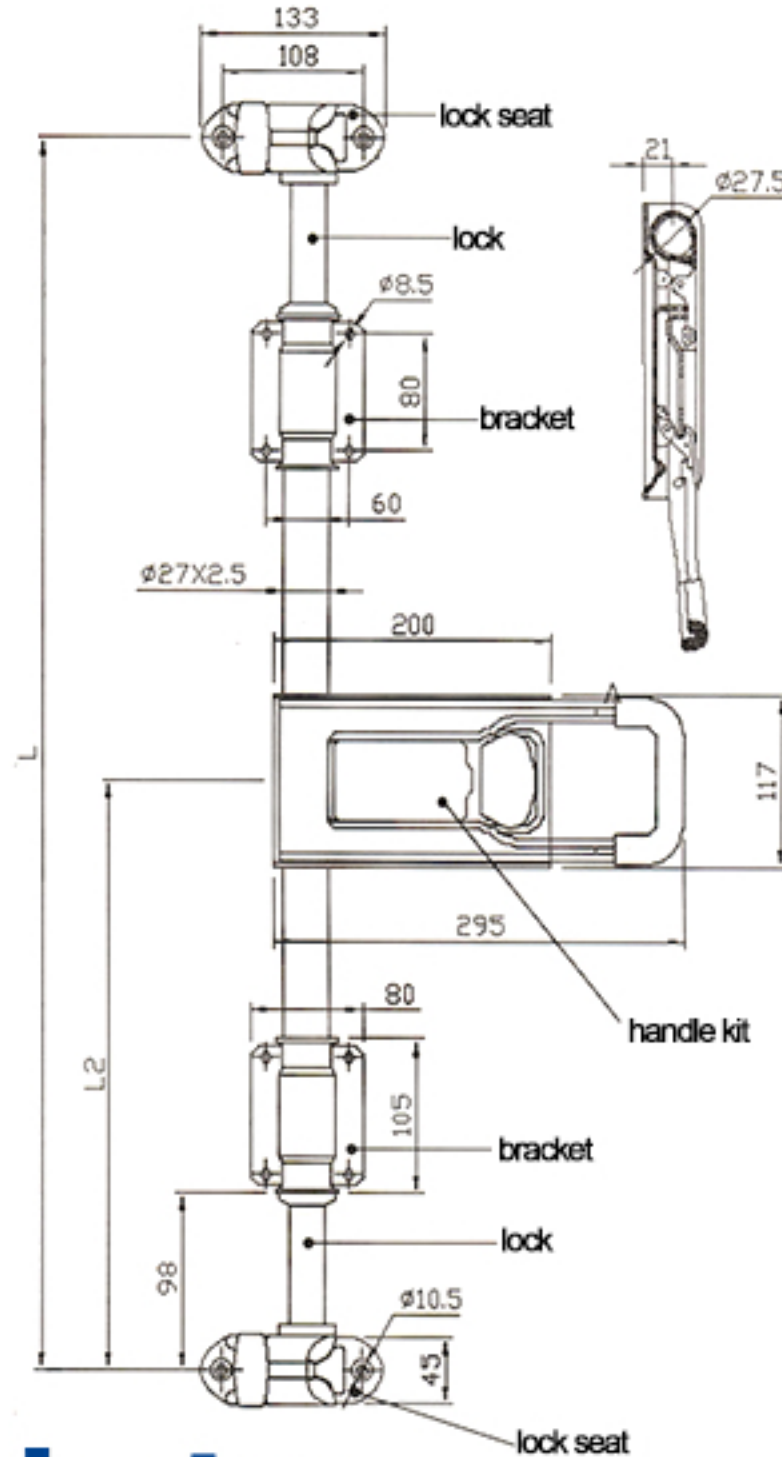

Tower Industry
YOUR MANUFACTURING BASE IN CHINA

Sales@tower-machinery.com
www.tower-machinery.com

TW-DL890
TW-DL890S
Compression Lock

Weight: 5.5kg / 5.4kg

MATERIAL: Steel / stainless steel

FINISH: Zinc / polish