

TECHNICAL DRAWING

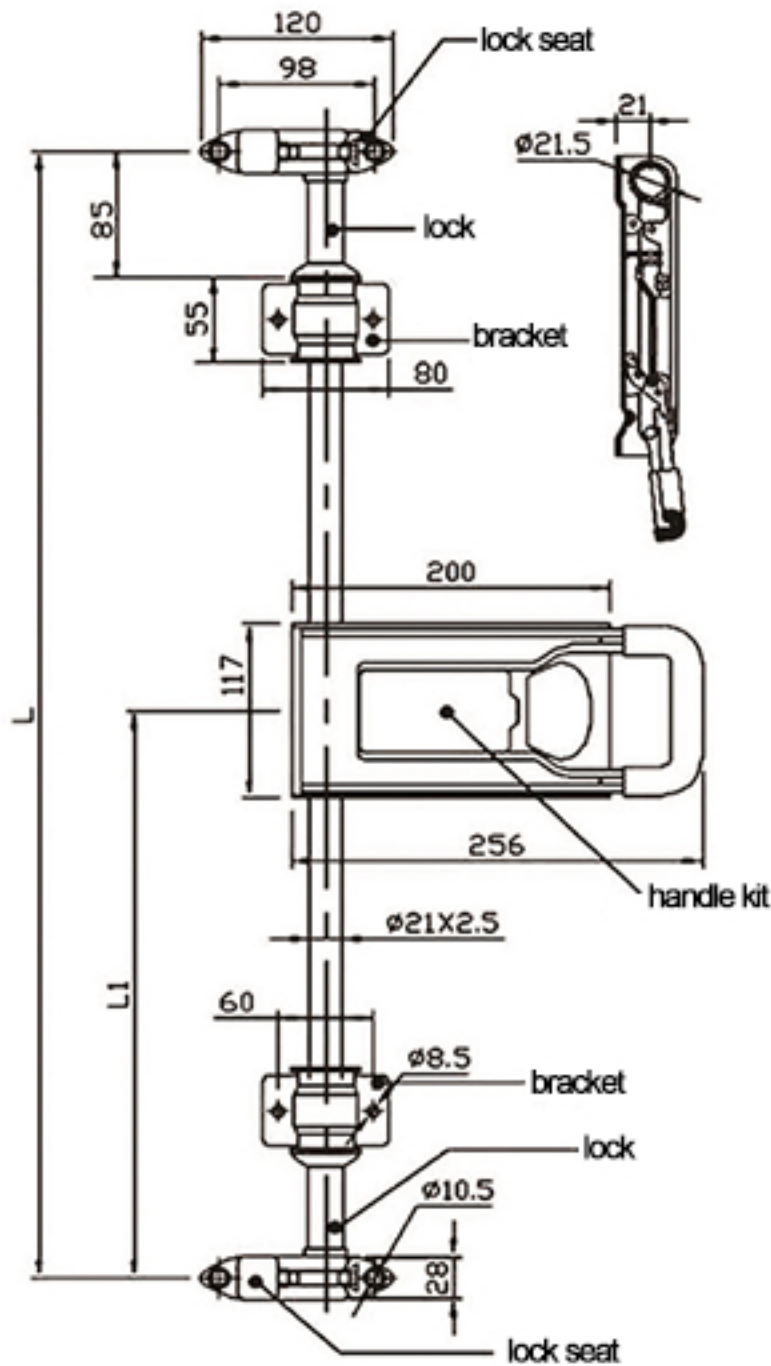

Tower Industry
YOUR MANUFACTURING BASE IN CHINA

Sales@tower-machinery.com
www.tower-machinery.com

TW-DL889
TW-DL889S
Compression Lock

Weight: 3.8kg / 3.4kg

MATERIAL: Steel / stainless steel

FINISH: Zinc / polish