

TECHNICAL DRAWING

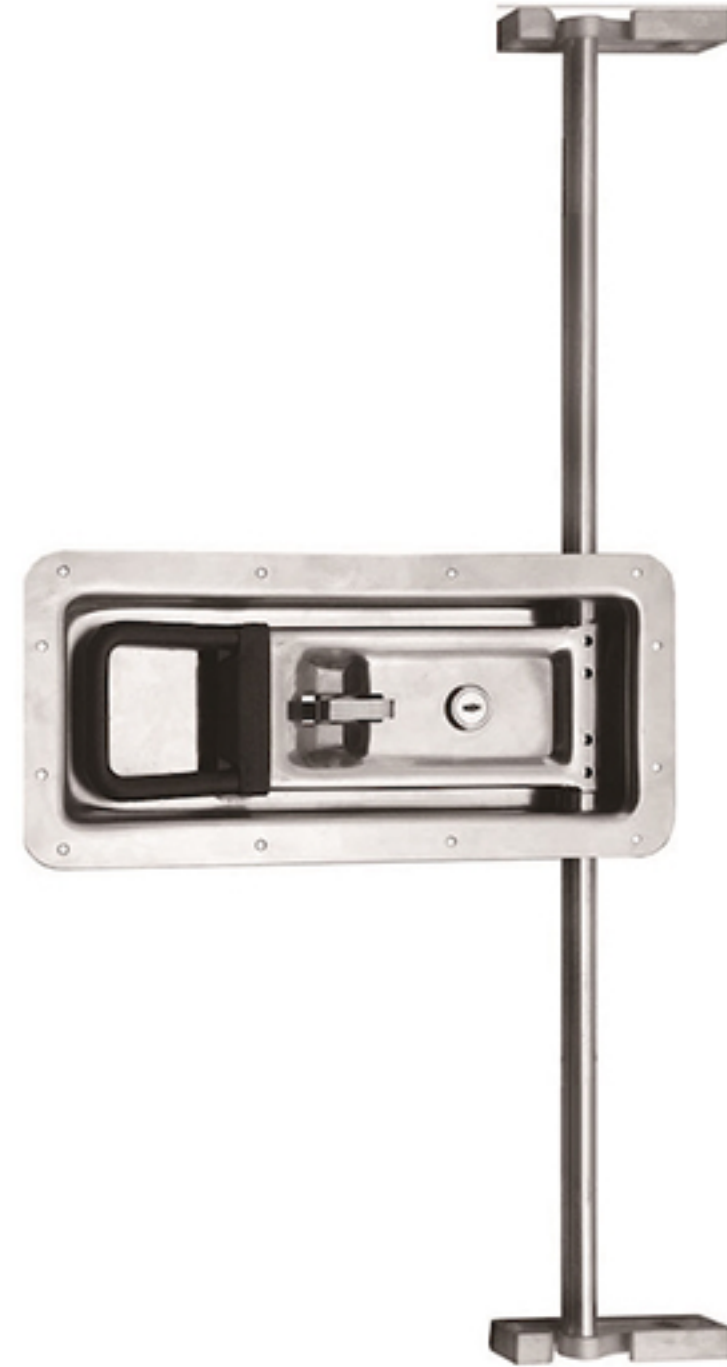
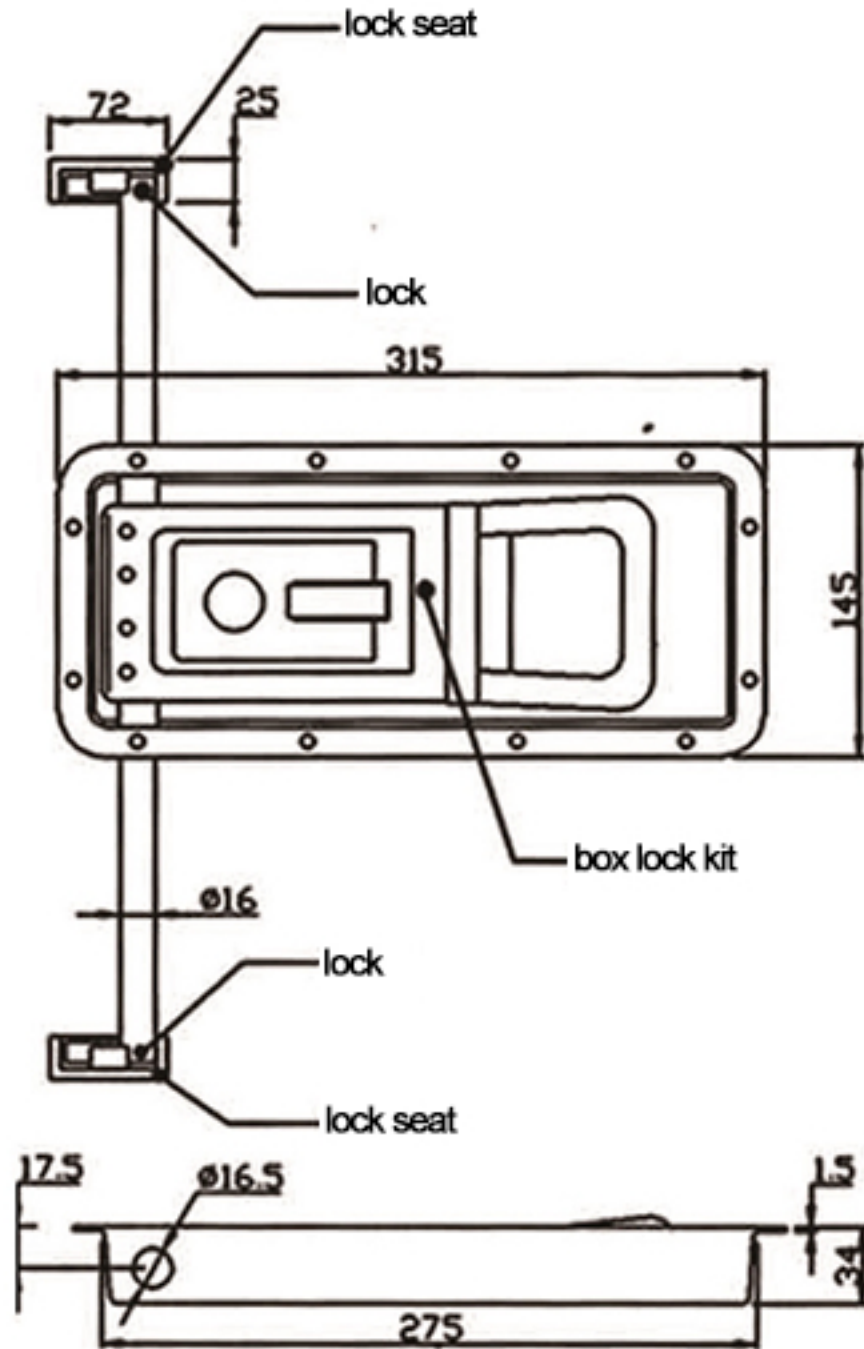

Tower Industry
YOUR MANUFACTURING BASE IN CHINA

Sales@tower-machinery.com
www.tower-machinery.com

TW-DL886
TW-DL886S
Compression Lock

Weight: 3.3kg / 2.9kg

MATERIAL: Steel / stainless steel

FINISH: Zinc / polish