

TECHNICAL DRAWING

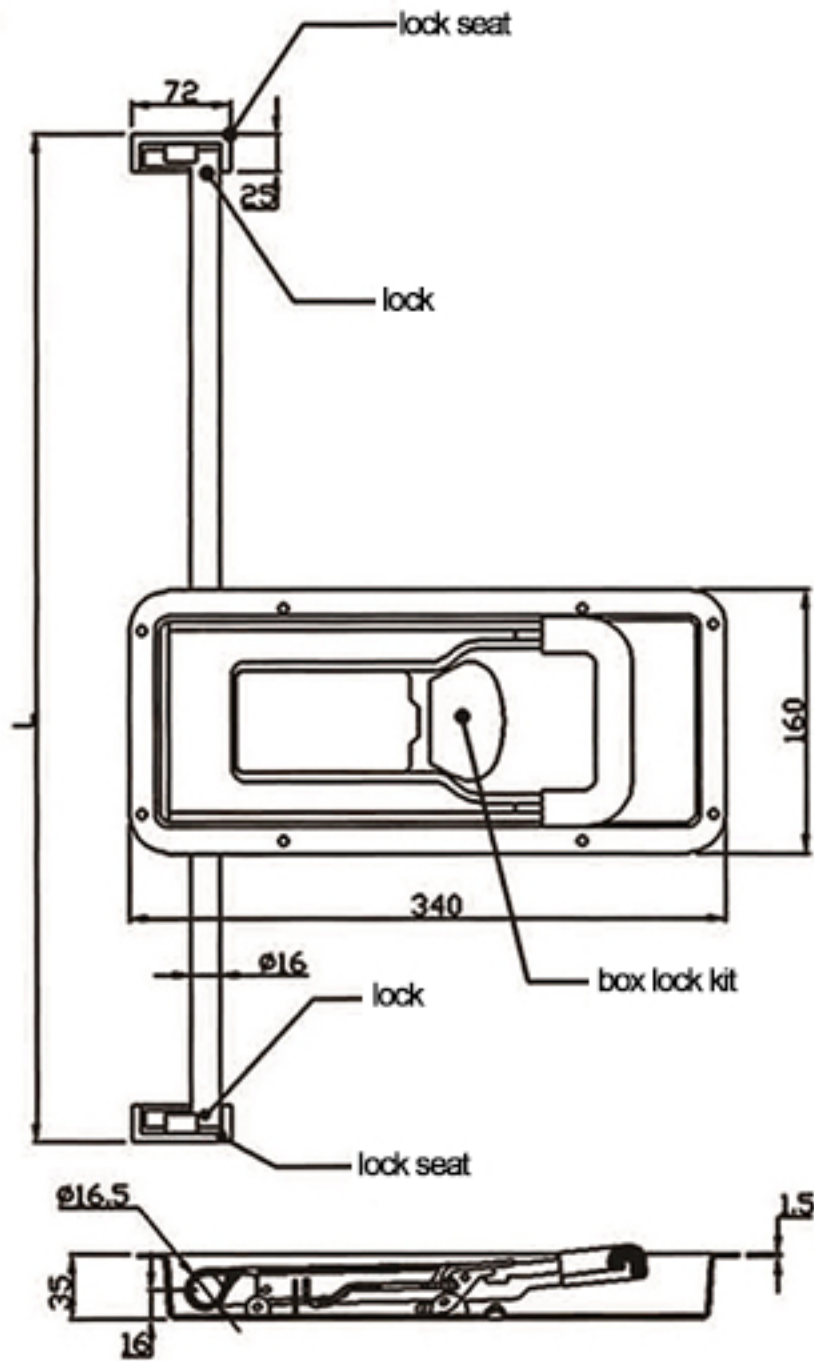

Tower Industry
YOUR MANUFACTURING BASE IN CHINA

Sales@tower-machinery.com
www.tower-machinery.com

TW-DL885
TW-DL885S
Compression Lock

Weight: 2.3kg / 2.15kg

MATERIAL: Steel / stainless steel

FINISH: Zinc / polish