

TECHNICAL DRAWING

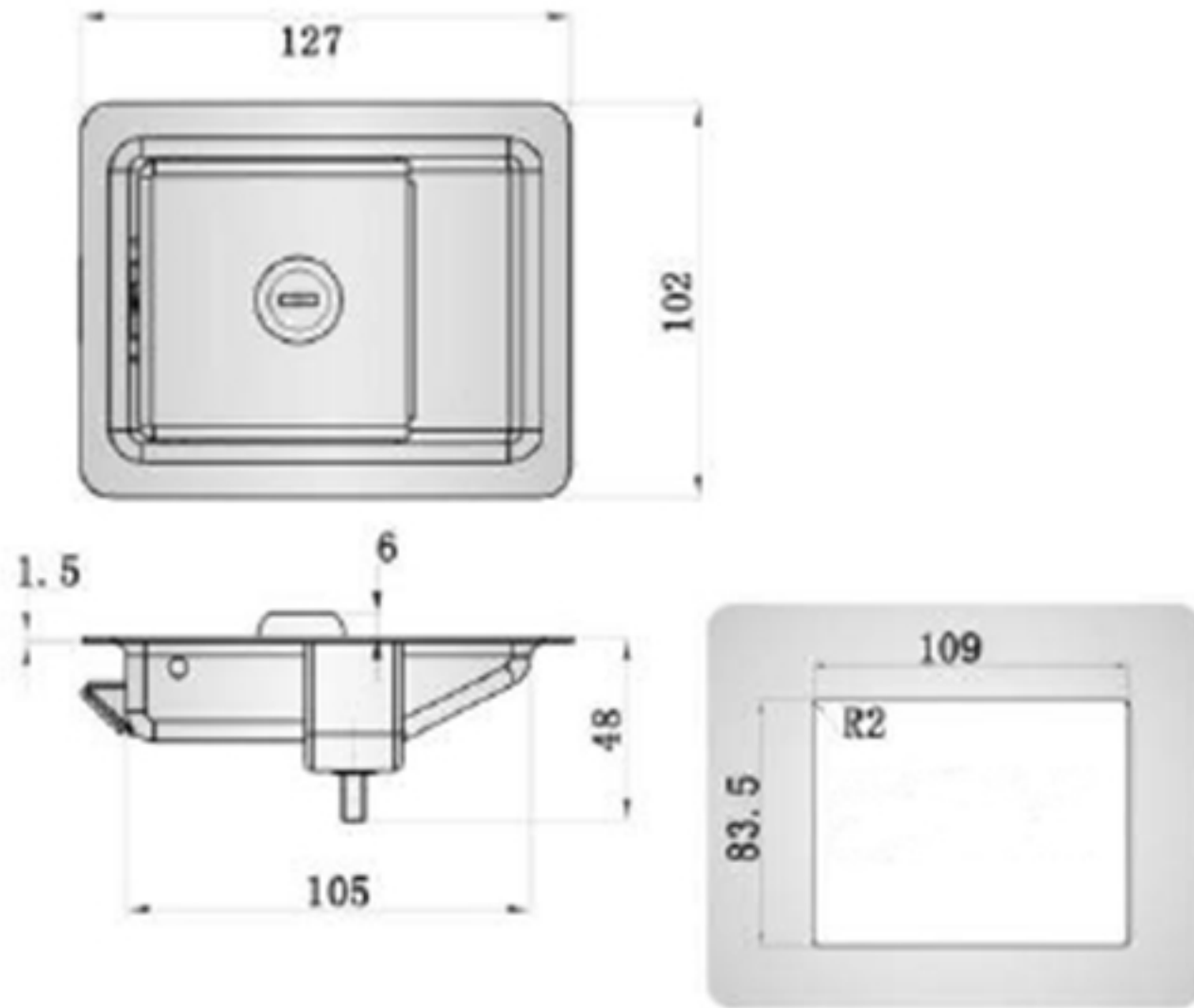

Tower Industry
YOUR MANUFACTURING BASE IN CHINA

Sales@tower-machinery.com
www.tower-machinery.com

TW-LP313
TW-LP313S
Paddle Lock

DIMENSIONS: 127mm x 102mm
MATERIAL: Steel / Stainless steel
FINISH: Power coated / Polish