

TECHNICAL DRAWING

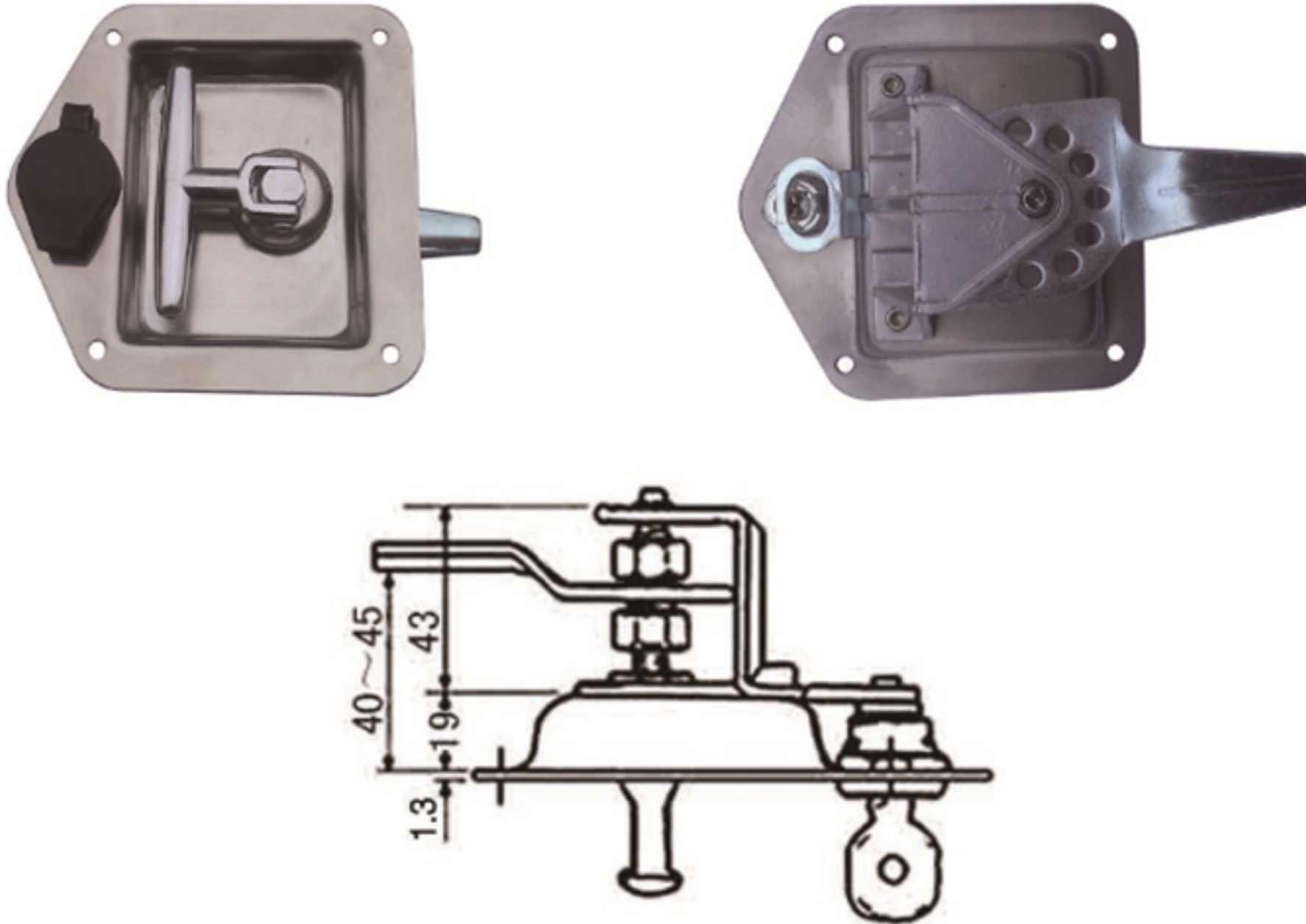

Tower Industry
YOUR MANUFACTURING BASE IN CHINA

Sales@tower-machinery.com
www.tower-machinery.com

TW-LP308
TW-LP308S
Paddle Lock

DIMENSIONS: 124mm x 121mm
MATERIAL: Steel / Stainless steel
FINISH: Zinc / No