

TECHNICAL DRAWING

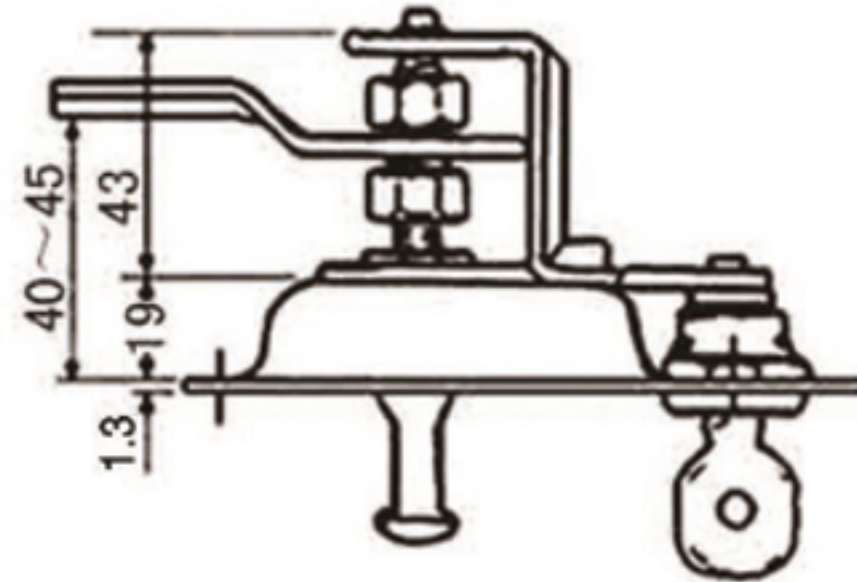
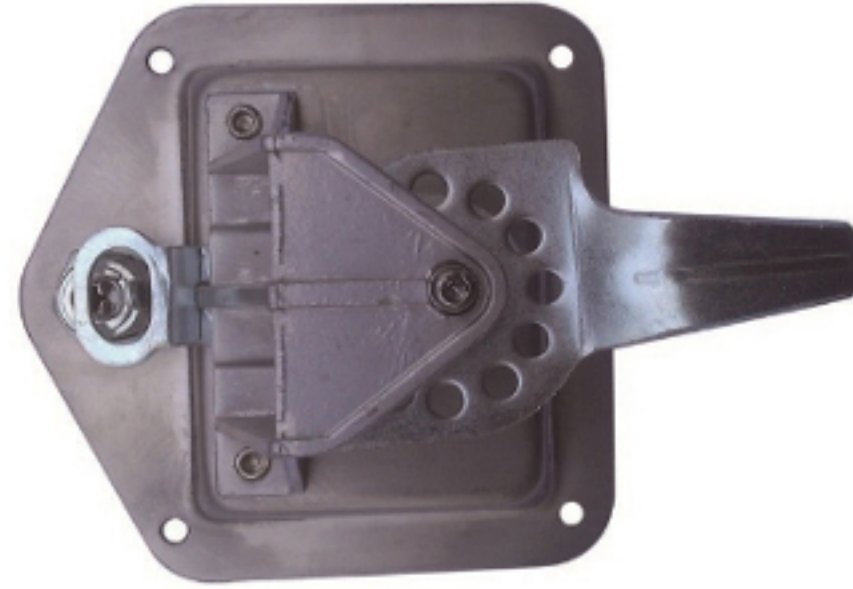
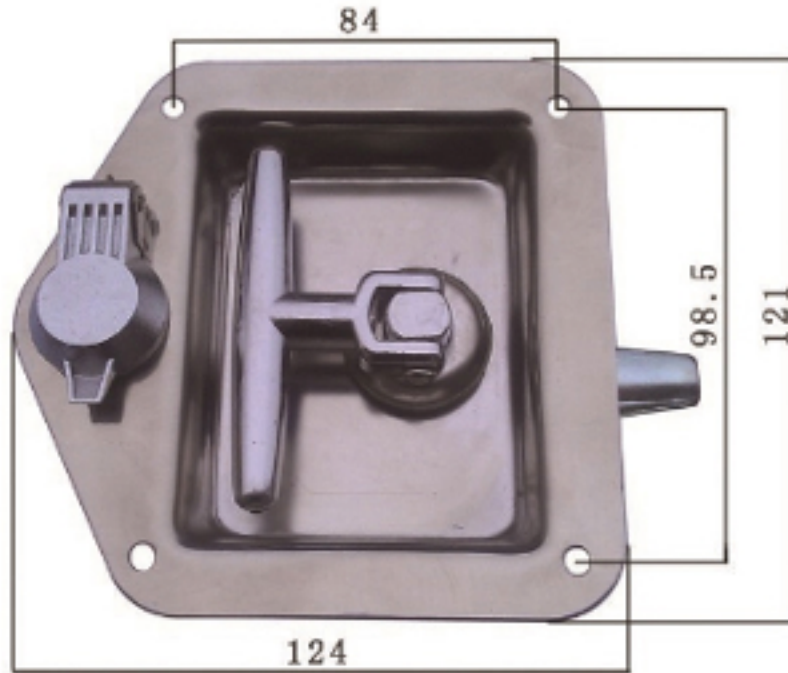

Tower Industry
YOUR MANUFACTURING BASE IN CHINA

Sales@tower-machinery.com
www.tower-machinery.com

TW-LP307
TW-LP307S

Paddle Lock

DIMENSIONS: 124mm x 121mm

MATERIAL: Steel / Stainless steel

FINISH: Zinc / No