

TECHNICAL DRAWING

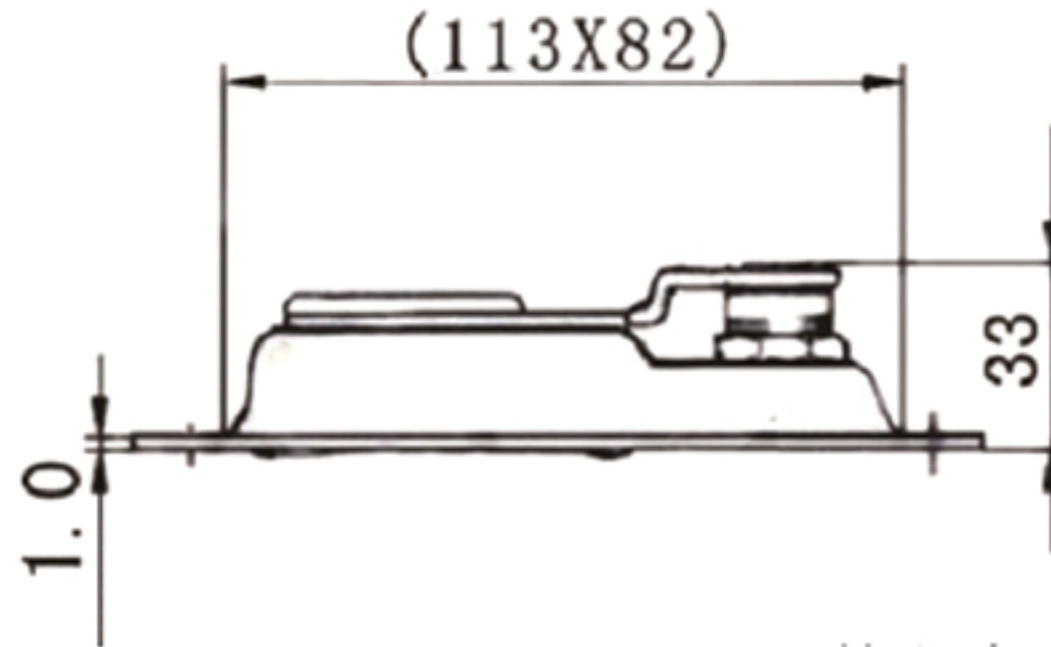
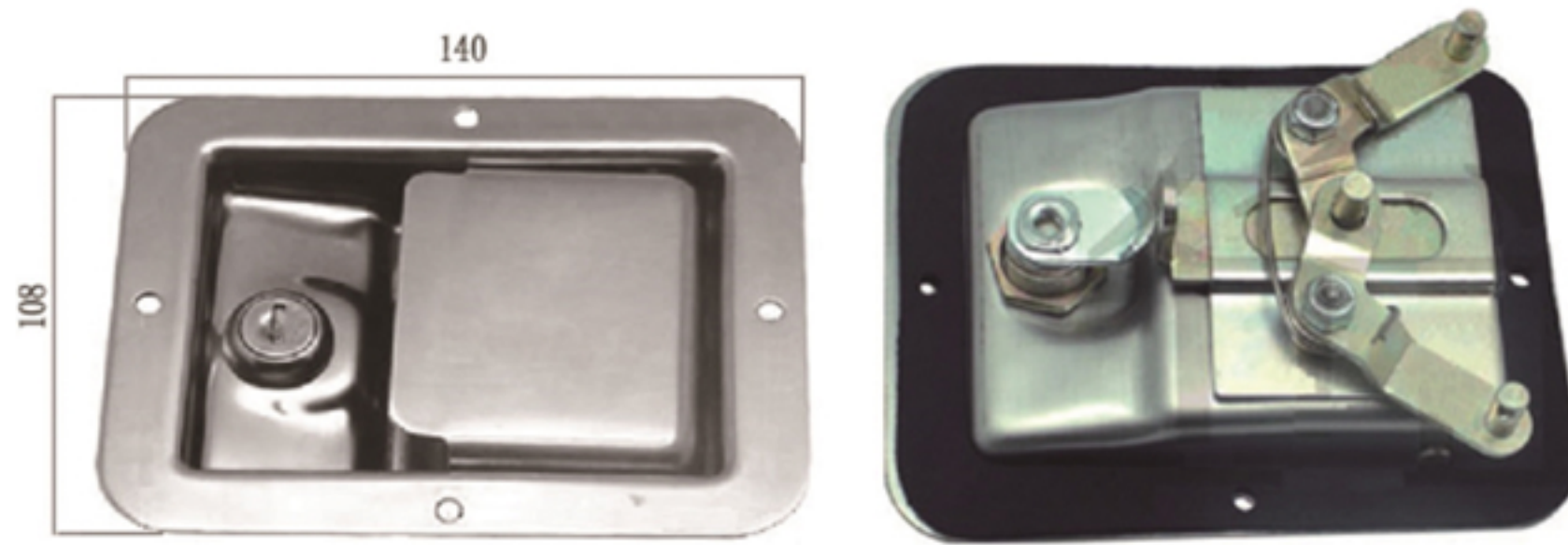

Tower Industry
YOUR MANUFACTURING BASE IN CHINA

Sales@tower-machinery.com
www.tower-machinery.com

TW-LP303
TW-LP303S

Paddle Lock

DIMENSIONS: 140mm x 108mm

MATERIAL: Steel / Stainless steel

FINISH: Zinc / No