

TECHNICAL DRAWING

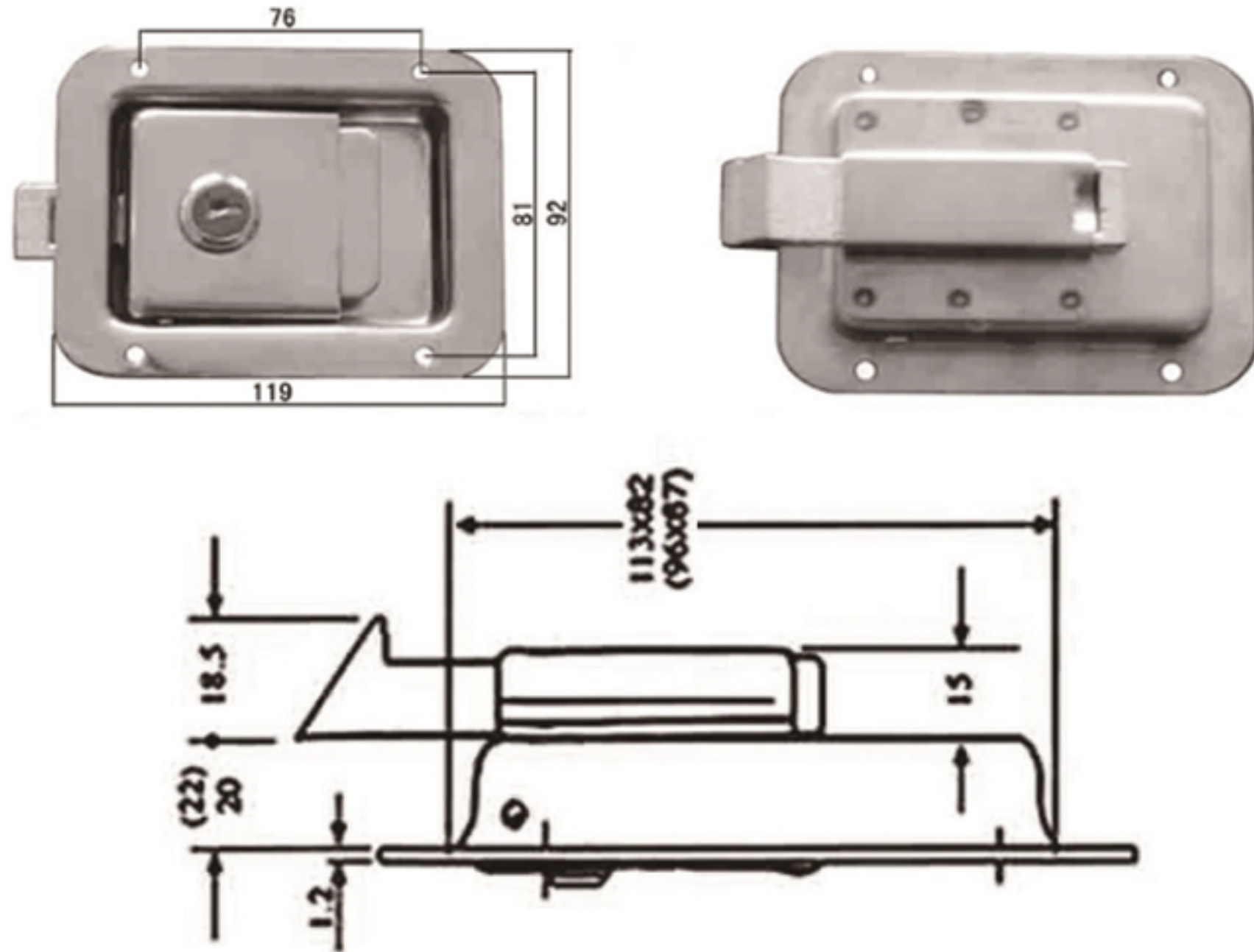

Tower Industry
YOUR MANUFACTURING BASE IN CHINA

Sales@tower-machinery.com
www.tower-machinery.com

TW-LP301
TW-LP301S

Paddle Lock

DIMENSIONS: 119mm x 92mm

MATERIAL: Steel / Stainless steel

FINISH: Zinc / No