

# TECHNICAL DRAWING

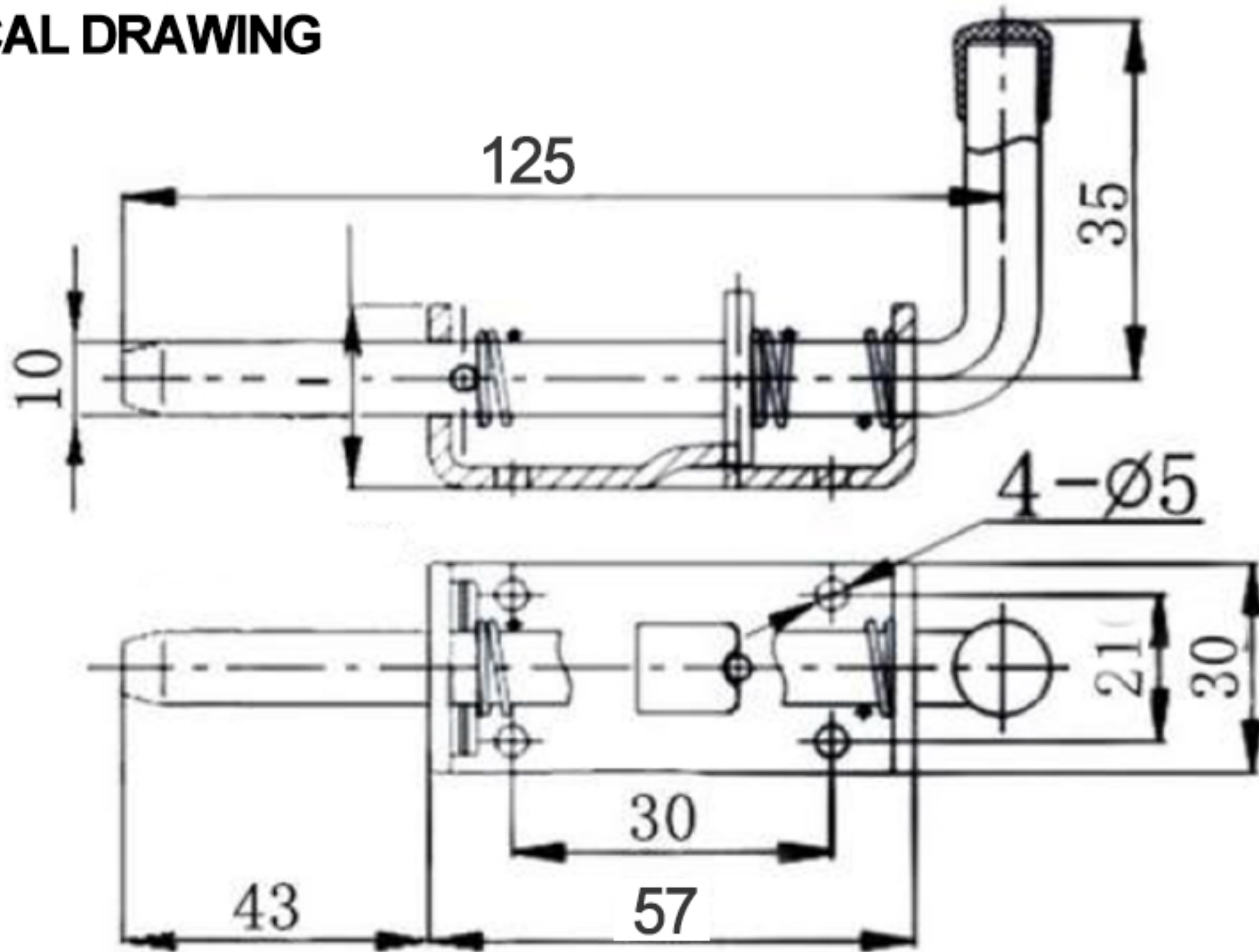

**Tower Industry**

YOUR MANUFACTURING BASE IN CHINA

Sales@tower-machinery.com

www.tower-machinery.com

TW-S-001

Spring Latch

DIMENSIONS: 130mm

MATERIAL: Steel / Stainless steel

FINISH: Zinc / No