

# TECHNICAL DRAWING

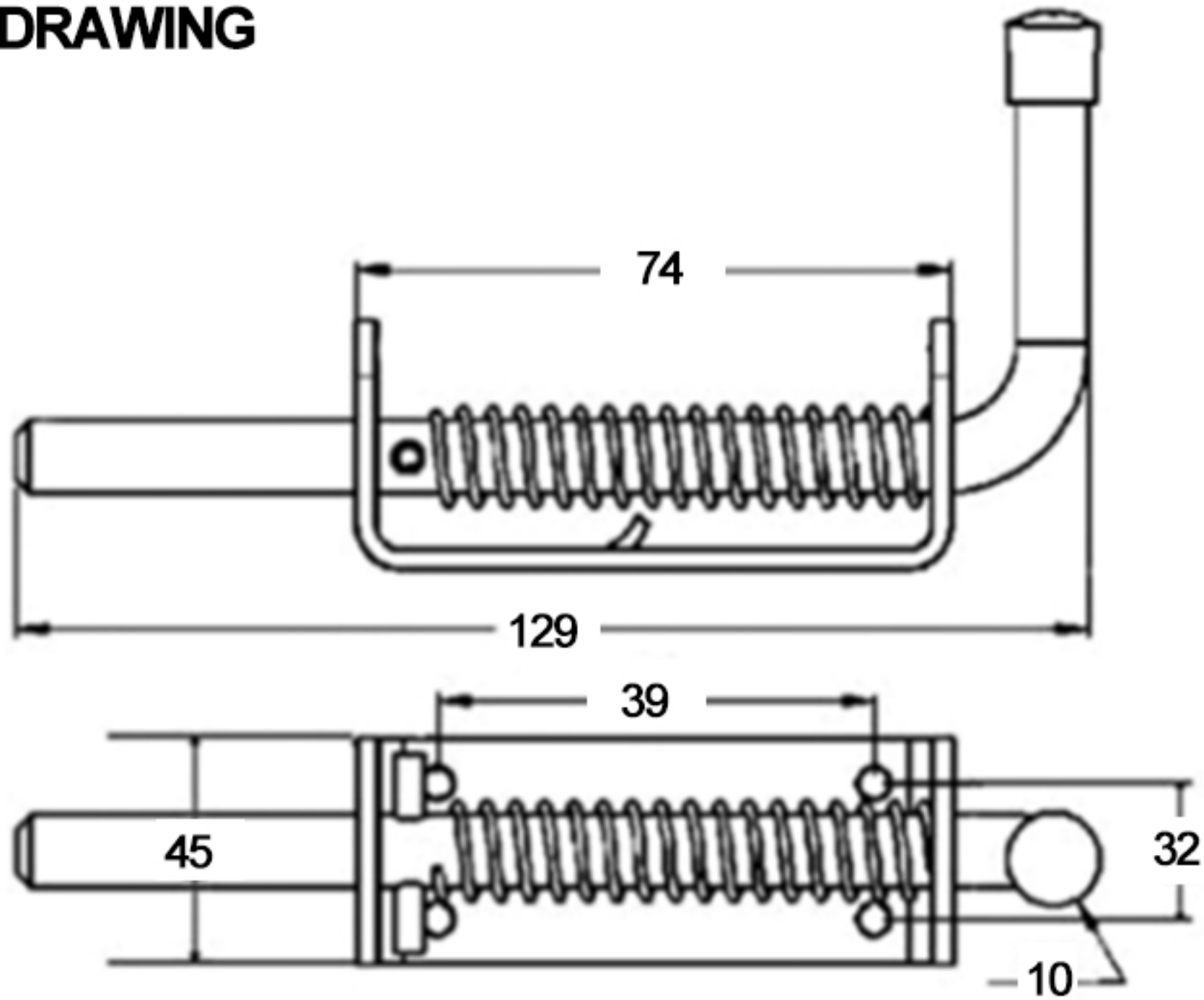

**Tower Industry**

YOUR MANUFACTURING BASE IN CHINA

Sales@tower-machinery.com

www.tower-machinery.com

TW-B-010

Spring Latch

DIMENSIONS: 129mm

MATERIAL: Steel / Stainless steel

FINISH: Zinc / No