

# TECHNICAL DRAWING

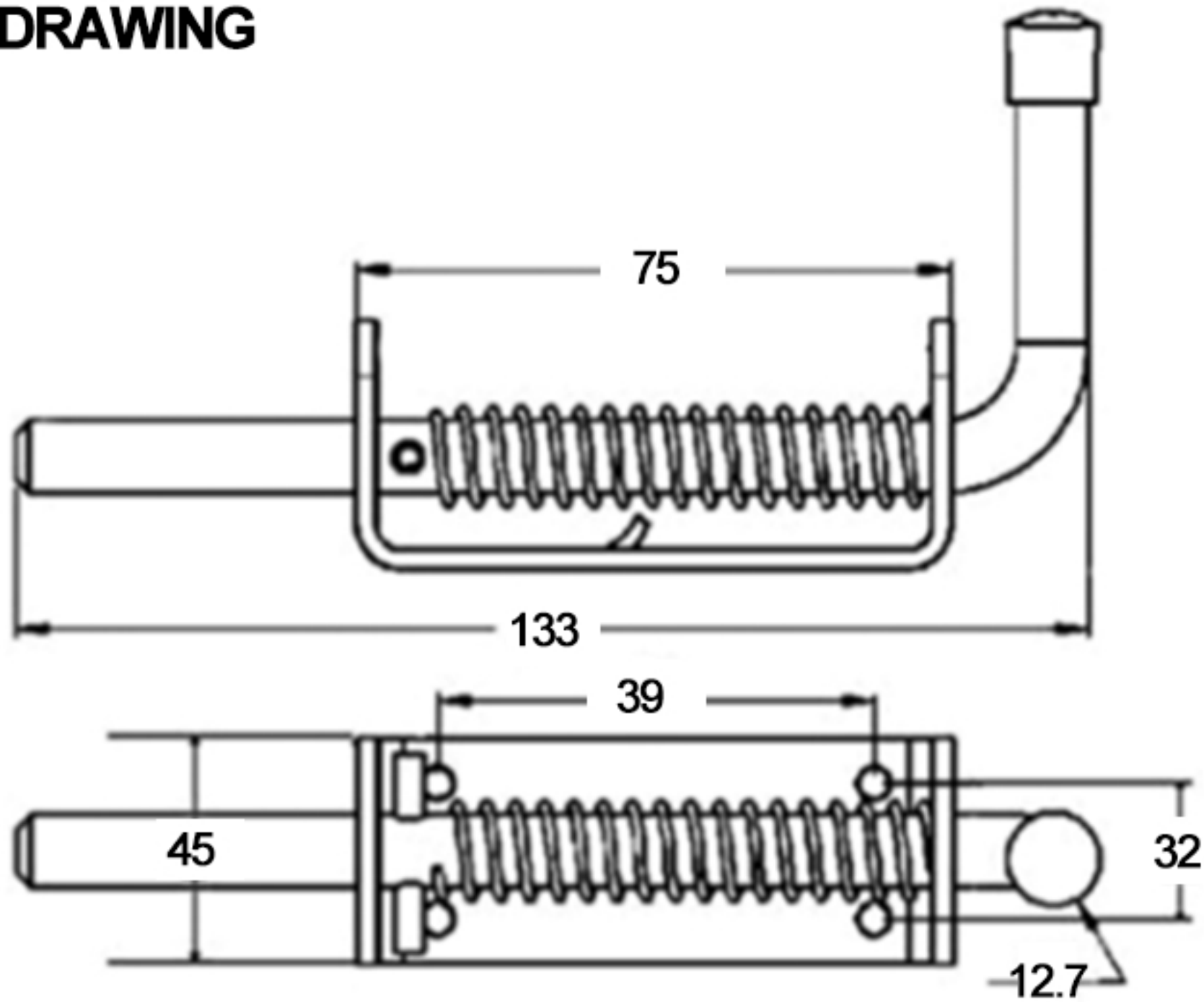

**Tower Industry**

YOUR MANUFACTURING BASE IN CHINA

Sales@tower-machinery.com

www.tower-machinery.com

TW-B-009

Spring Latch

DIMENSIONS: 133mm

MATERIAL: Steel / Stainless steel

FINISH: Zinc / No