

TECHNICAL DRAWING

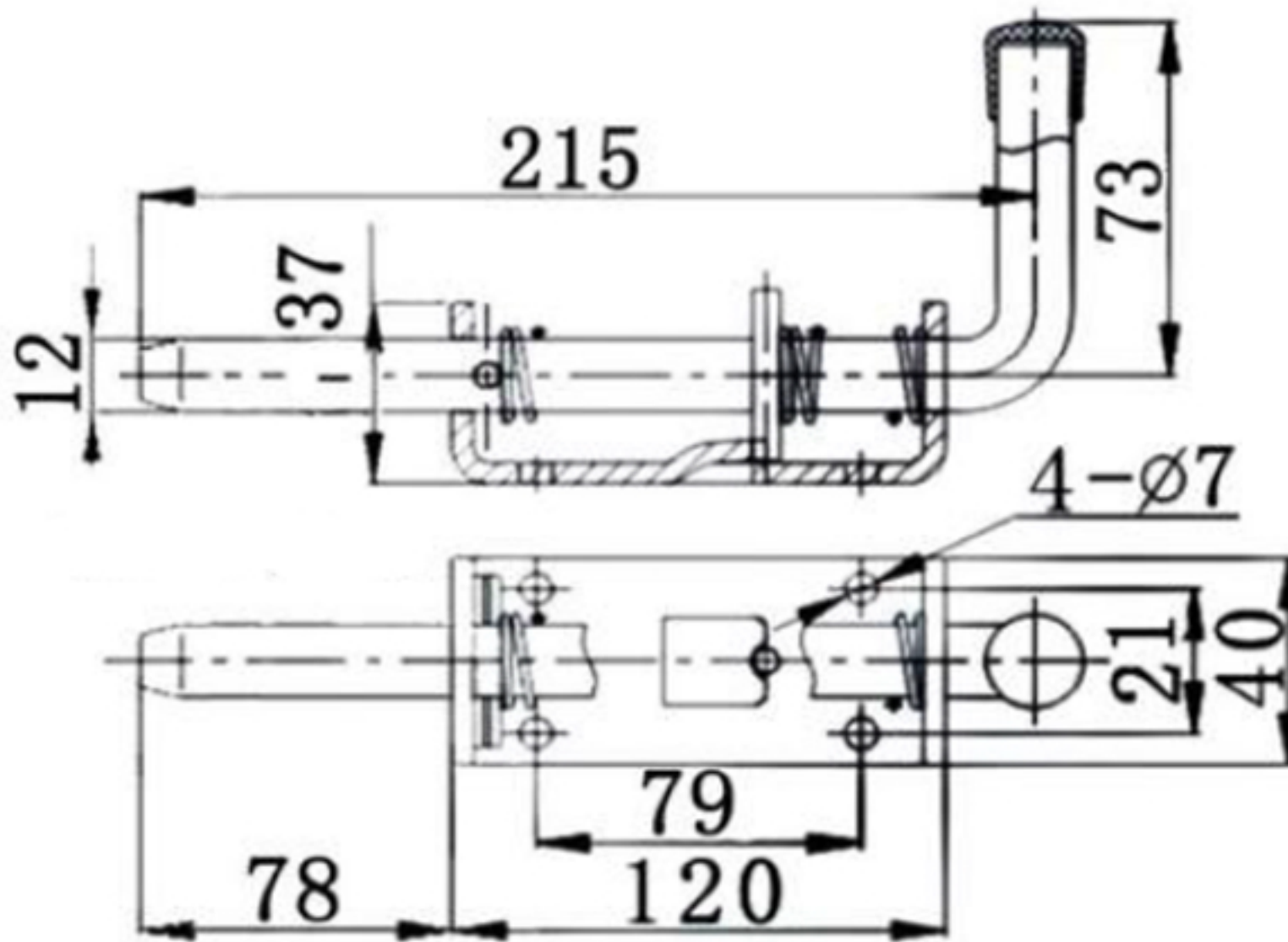

Tower Industry
YOUR MANUFACTURING BASE IN CHINA

Sales@tower-machinery.com
www.tower-machinery.com

TW-B-004
Spring Latch

DIMENSIONS: 221mm

MATERIAL: Steel / Stainless steel

FINISH: Zinc / No