

TECHNICAL DRAWING

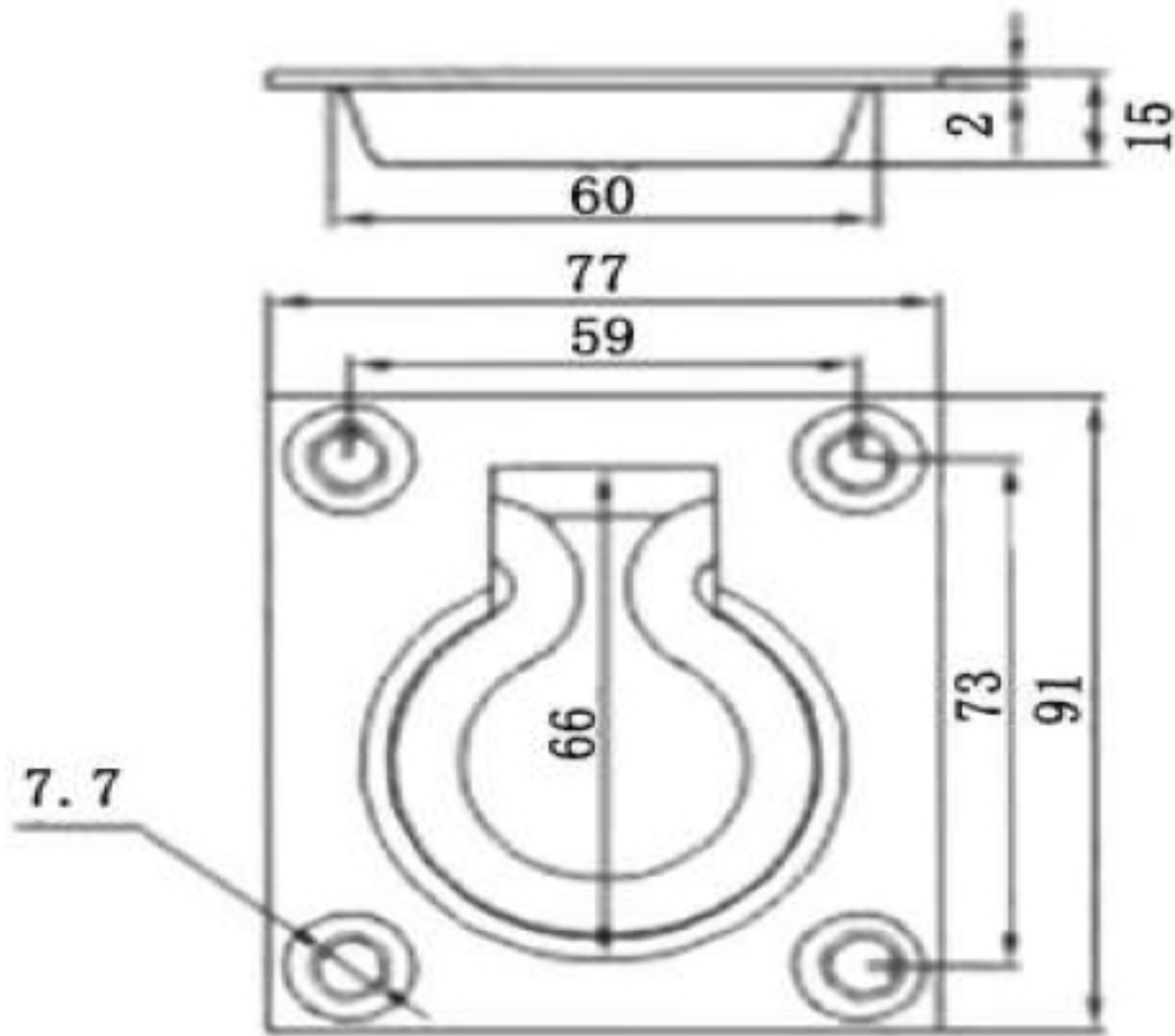

Tower Industry
YOUR MANUFACTURING BASE IN CHINA

Sales@tower-machinery.com
www.tower-machinery.com

TW-DL604
TW-DR604S
Tie Downs

Dimension: 77mm x 91mm

MATERIAL: Steel / stainless steel

FINISH: Zinc / polish