

TECHNICAL DRAWING

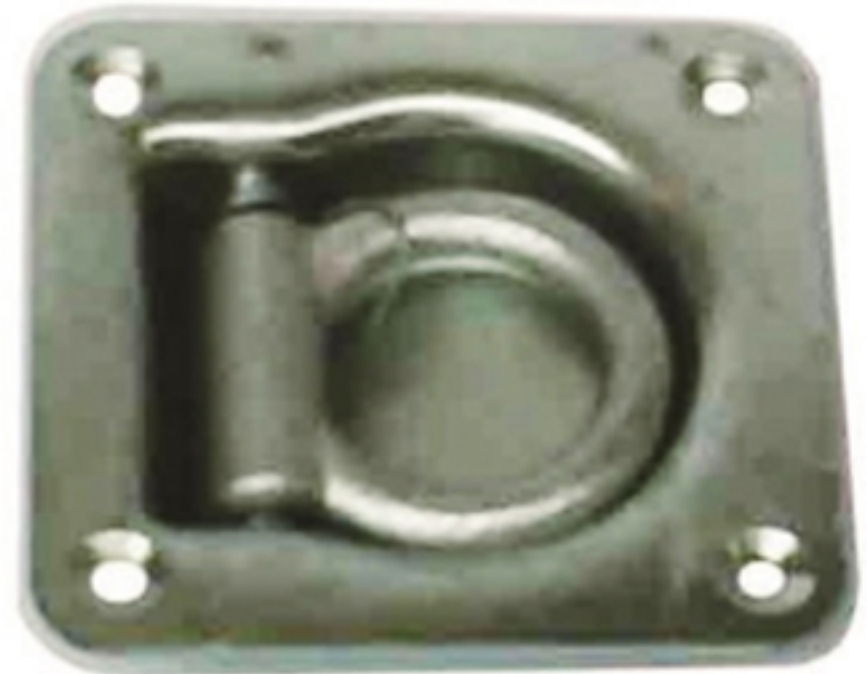
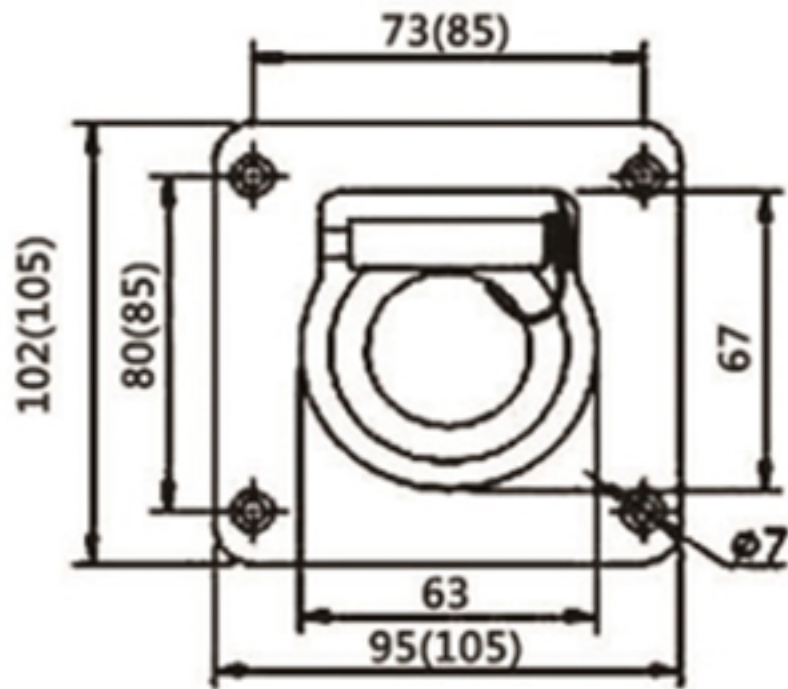

Tower Industry
YOUR MANUFACTURING BASE IN CHINA

Sales@tower-machinery.com
www.tower-machinery.com

TW-DL601
TW-DR601S
Tie Downs

Dimension: 95mm x 102mm
MATERIAL: Steel / stainless steel
FINISH: Zinc / polish