

TECHNICAL DRAWING

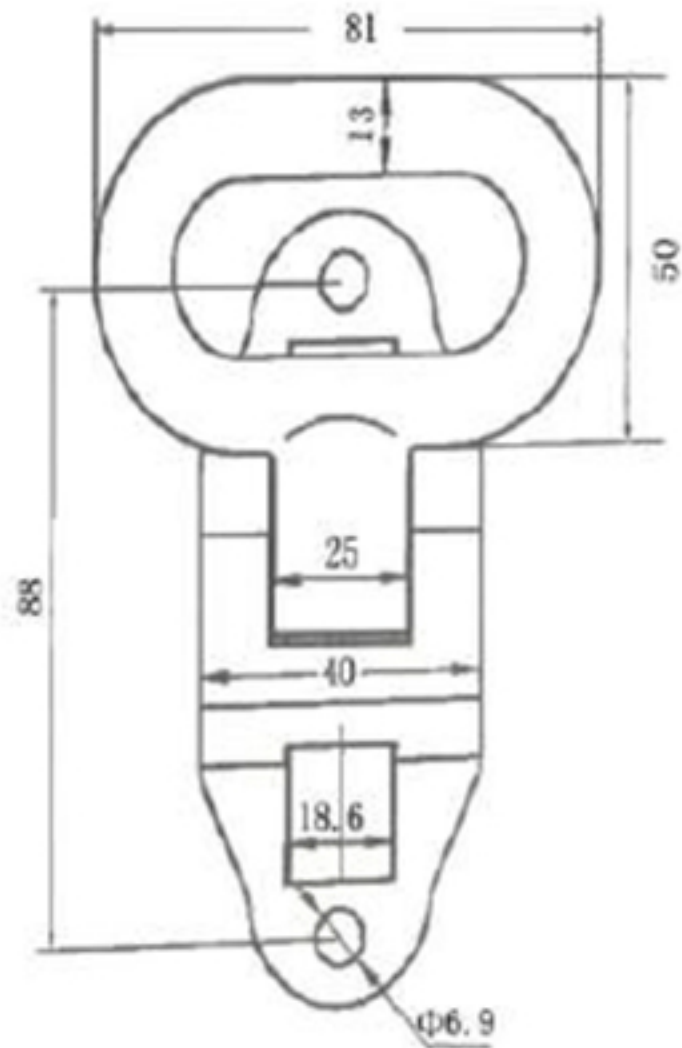

Tower Industry
YOUR MANUFACTURING BASE IN CHINA

Sales@tower-machinery.com
www.tower-machinery.com

TWFS102S

Folding Foot Step

DIMENSIONS: 81mm x 50mm

MATERIAL: Stainless steel

FINISH: Polished