

TECHNICAL DRAWING

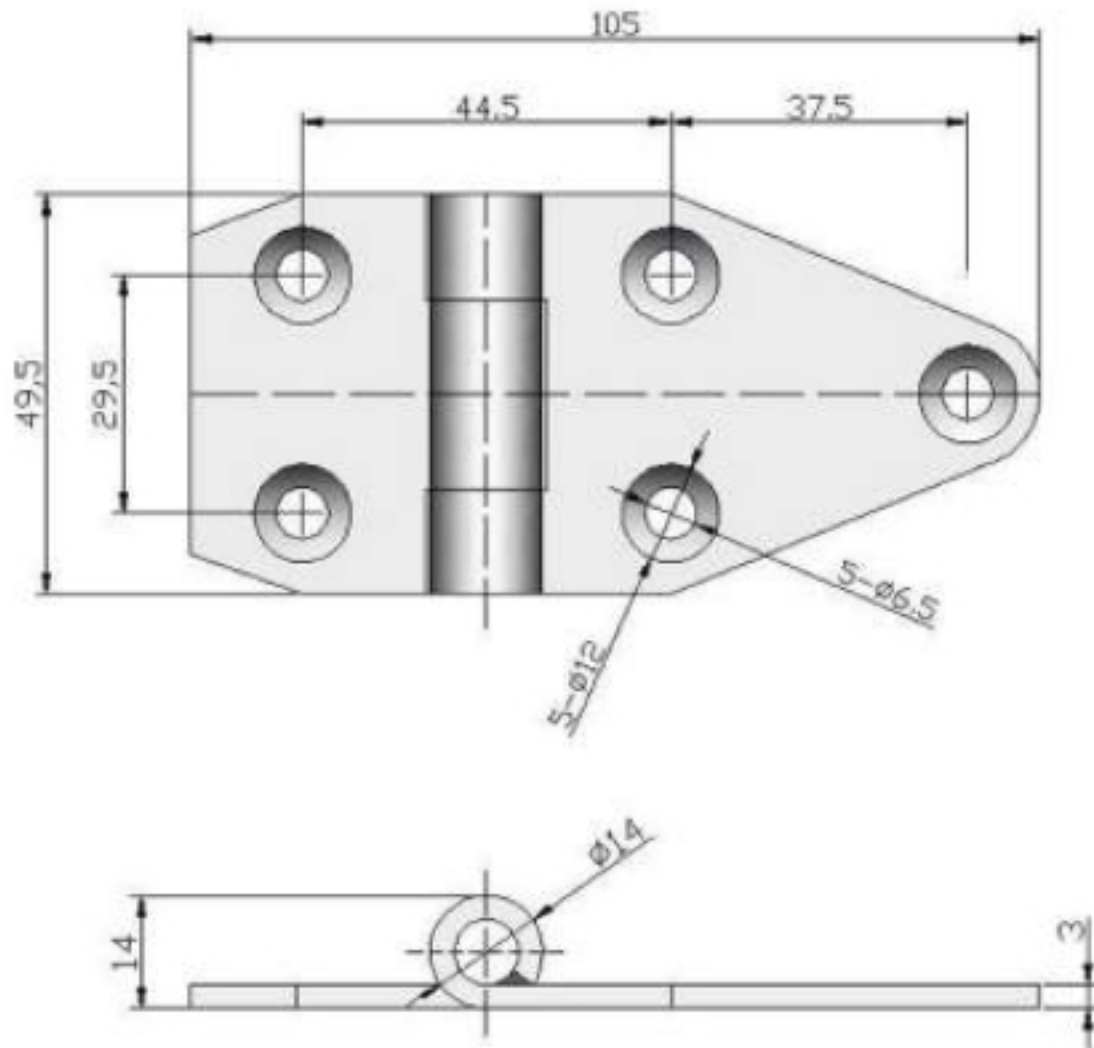

Tower Industry
YOUR MANUFACTURING BASE IN CHINA

Sales@tower-machinery.com
www.tower-machinery.com

TW-SH222
TW-SH222S
Strap Hinge

DIMENSIONS: 105mm

MATERIAL: Steel / Stainless steel

FINISH: Zinc / polished