

# TECHNICAL DRAWING

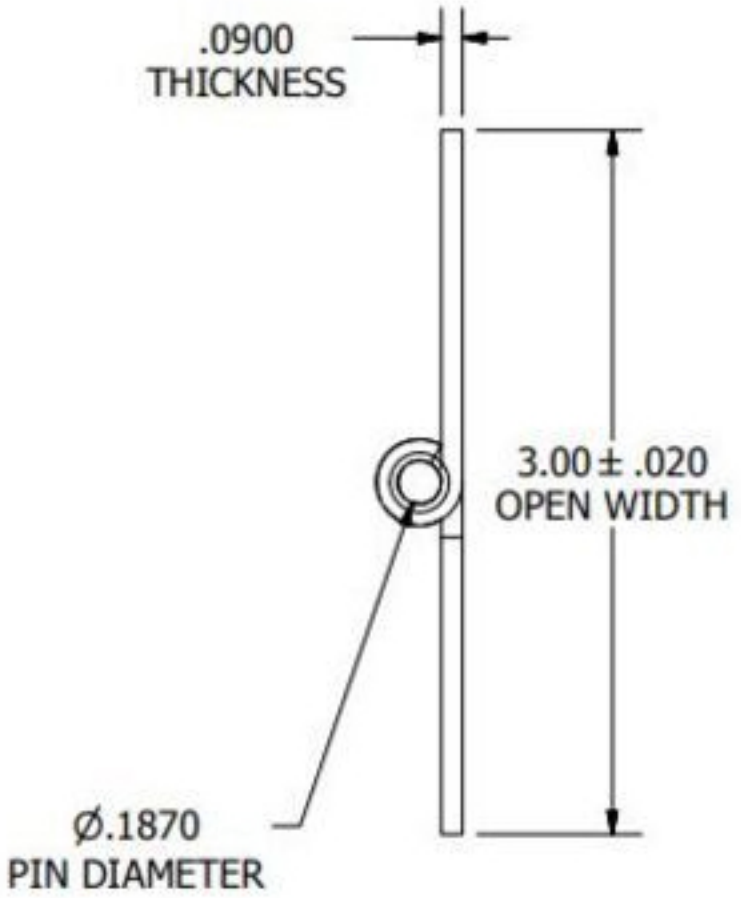
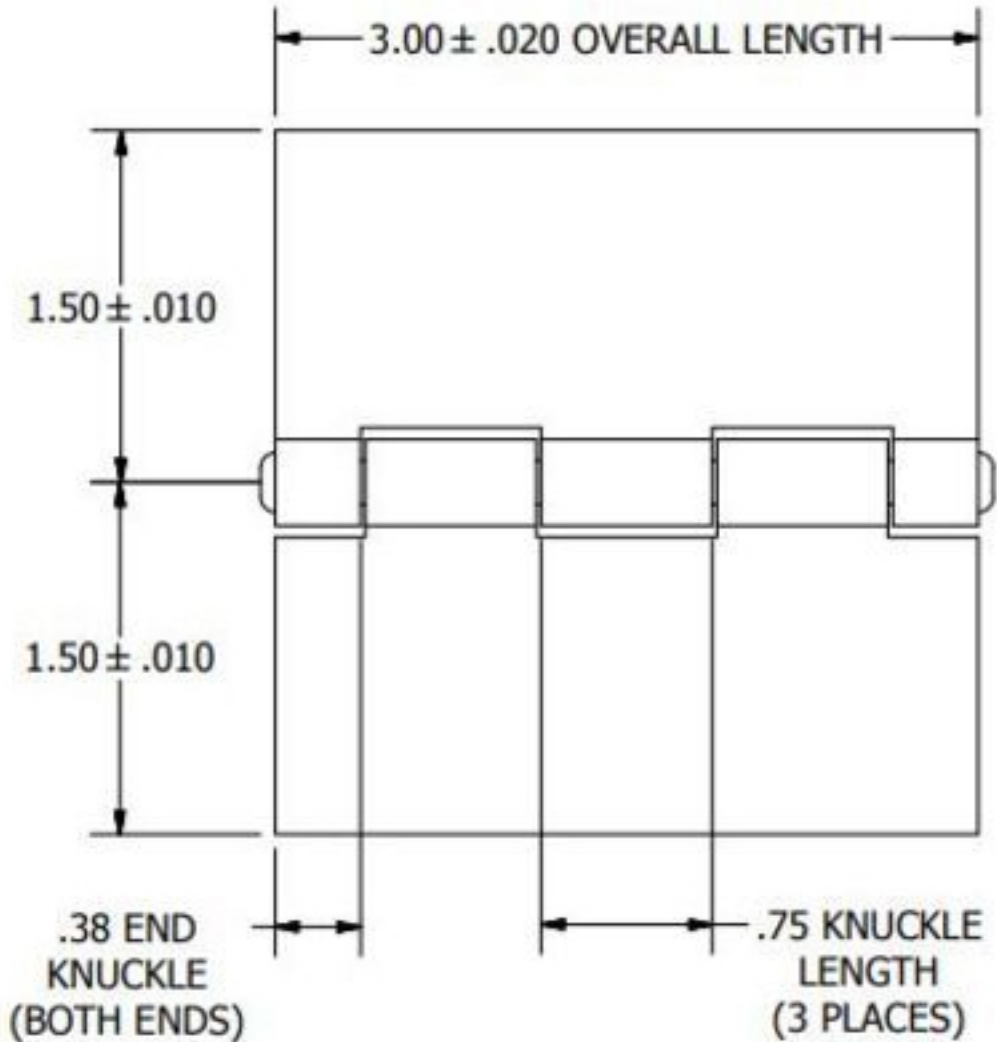

**Tower Industry**  
YOUR MANUFACTURING BASE IN CHINA

Sales@tower-machinery.com  
www.tower-machinery.com

TW-BH560-AL

Butt Hinge

DIMENSIONS: 3" x 3"

MATERIAL: Aluminum

FINISH: No