

TECHNICAL DRAWING

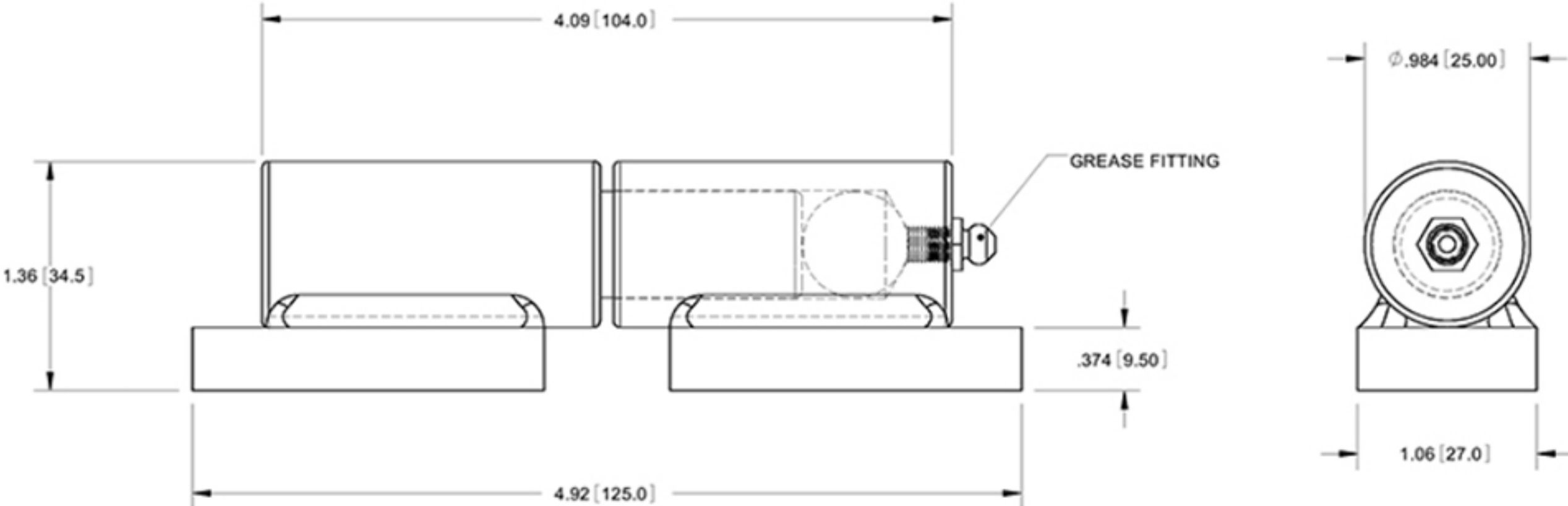

Tower Industry
YOUR MANUFACTURING BASE IN CHINA

Sales@tower-machinery.com
www.tower-machinery.com

TW-SBH5001
Barrel Hinge

DIMENSIONS: 5"
MATERIAL: Steel
FINISH: Power coated